



Micro Commercial Components™
 Micro Commercial Components 20736 Marilla Street Chatsworth
 CA 91311
 Phone: (818) 701-4933
 Fax: (818) 701-4939

BAT54T THRU BAT54ST

Features

- Ultra-Small Surface Mount Package
- Low Forward Voltage Drop
- Fast Switching
- PN Junction Guard Ring for Transient and ESD Protection
- Case Material: Molded Plastic. UL Flammability Classification Rating 94V-0 and MSL Rating 1

**150mWatt, 30Volt
Schottky Barrier Diode**

MCC Part Number	Device Marking	Type	Pin Configuration
BAT54T	L1	Single	Figure 1
BAT54AT	L2	Dual	Figure 2
BAT54CT	L3	Dual	Figure 3
BAT54ST	L4	Dual	Figure 4

SOT-523

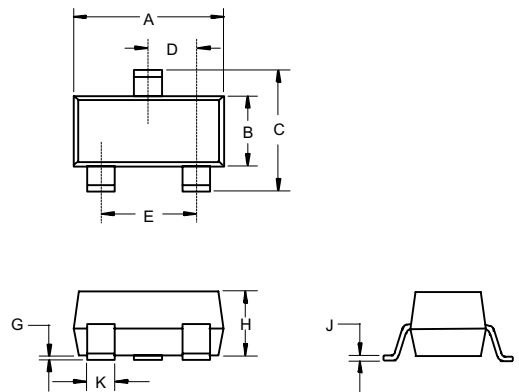

Maximum Ratings

DC Blocking Voltage	V_R	30V
Average Rectified Output Current	I_O	200mA
Repetitive Peak Forward Current	I_{FRM}	300mA
Non-Repetitive Peak Forward Current $t < 1s$	I_{FSM}	600mA
Total Power Dissipation @ $T_A = 25^\circ C$	P_D	150mW
Storage Temperature Range	T_{stg}	$-65^\circ C$ to $125^\circ C$
Junction Temperature	T_j	$-65^\circ C$ to $125^\circ C$
Thermal Resistance Junction to Ambient	$R_{\theta JA}$	667°C/W

Electrical Characteristics @ 25°C Unless Otherwise Specified

Ratings	Symbol	Max.	Notes
Forward Voltage	V_F	240mV	$I_F = 0.1mA$
		320mV	$I_F = 1mA$
		400mV	$I_F = 10mA$
		500mV	$I_F = 30mA$
		1000mV	$I_F = 100mA$
Reverse Current	I_R	2 μA	$V_R = 25V$
Reverse Breakdown Voltage	$V_{(BR)}$	>30V	$I_R = 100\mu A$
Total Capacitance	C_T	10pF	Measured at 1.0MHz, $V_R = 1.0V$
Reverse Recovery Time	t_{rr}	5nS	$I_F = 10mA$; $I_R = 10mA \sim 1.0mA$, $R_L = 100 \Omega$

DIM	DIMENSIONS				NOTE
	INCHES		MM		
A	.059	.067	1.50	1.70	
B	.030	.033	0.75	0.85	
C	.057	.069	1.45	1.75	
D	.020 Nominal		0.50 Nominal		
E	.035	.043	0.90	1.10	
G	.000	.004	.000	.100	
H	.028	.031	.70	0.80	
J	.004	.008	.100	.200	
K	.010	.014	.25	.35	

BAT54T thru BAT54ST

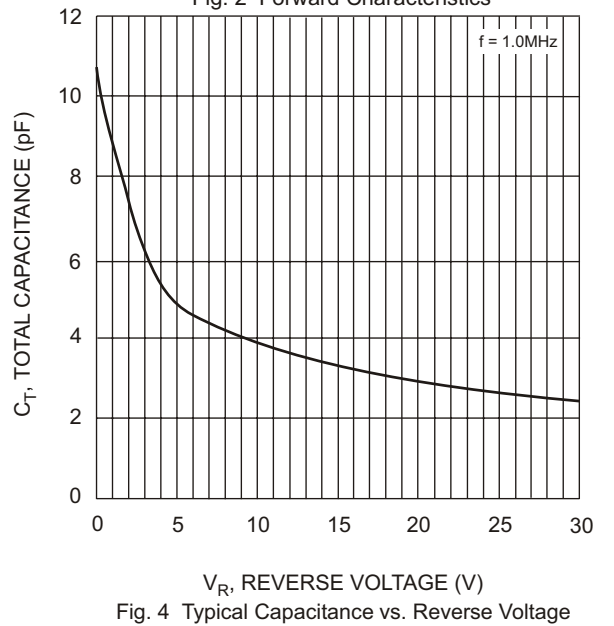
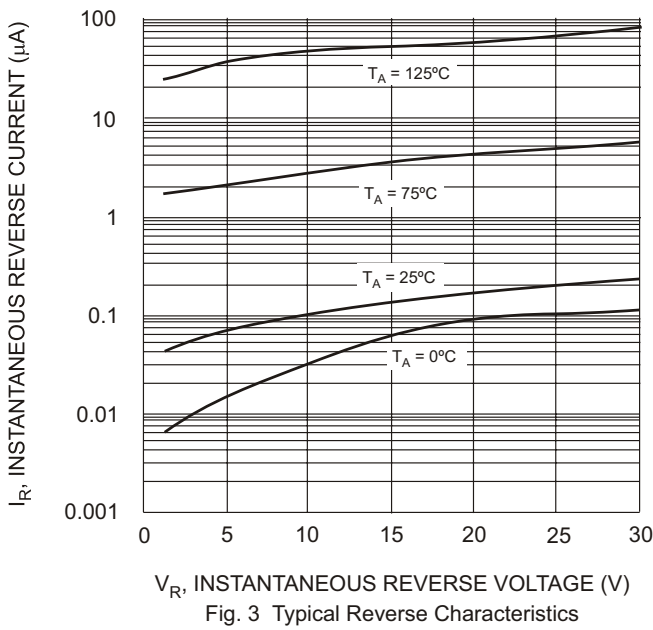
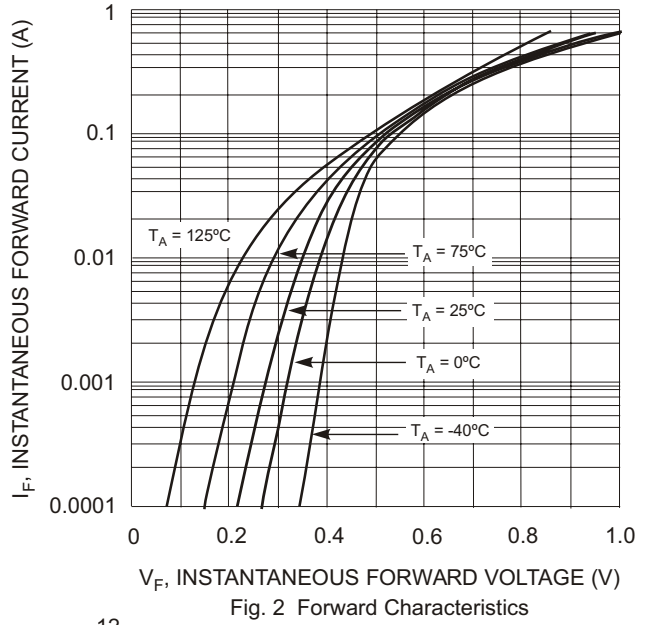
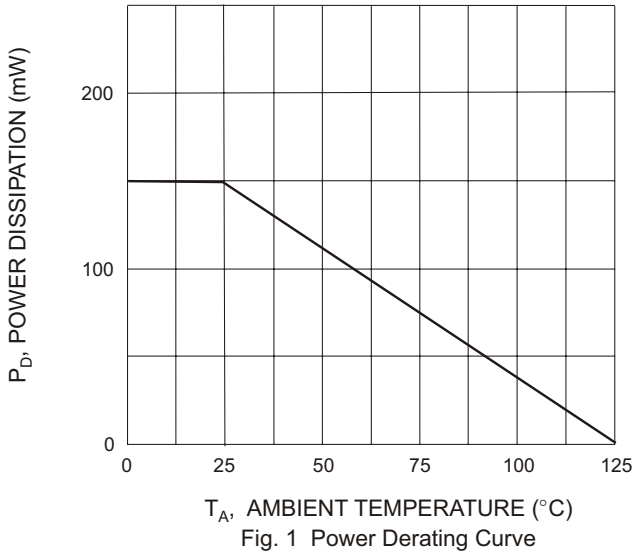

Pin Configuration - Top View

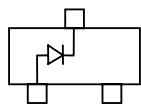

Figure 1

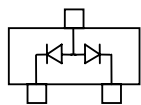

Figure 2

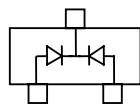

Figure 3

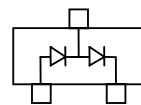

Figure 4



Micro Commercial Components

Ordering Information

Device (Part Number)-TP	Packing Tape&Reel;3Kpcs/Reel
----------------------------	---------------------------------

*****IMPORTANT NOTICE*****

Micro Commercial Components Corp. reserves the right to make changes without further notice to any product herein to make corrections, modifications, enhancements, improvements, or other changes. *Micro Commercial Components Corp.* does not assume any liability arising out of the application or use of any product described herein; neither does it convey any license under its patent rights, nor the rights of others. The user of products in such applications shall assume all risks of such use and will agree to hold *Micro Commercial Components Corp.* and all the companies whose products are represented on our website, harmless against all damages.

*****APPLICATIONS DISCLAIMER*****

Products offer by *Micro Commercial Components Corp.* are not intended for use in Medical, Aerospace or Military Applications.